

# Thermal-Link (OTCO)-Organic Type

RS Series  $I_r$ : 10A



## Description

Organic Thermal-Link (OTCO) is defined as a non-resettable protective device, functioning one time only. It mainly consists of metal case, spring, sliding contact and thermal pellet. When the Thermal-Link senses abnormal heat and temp. reaches the predetermined fusing temp., thermal pellet melts and the sliding contact separates from the isolated lead with the assistance of the trip spring, thereby the circuit is disconnected

SETsafe | SETfuse Organic Thermal-Link (OTCO) RS series Rated Functioning Temp. from 72 °C to 263 °C, Rated Current: 10 A, safety certification Includes UL, cUL, PSE, VDE, KC, CCC, and complies with RoHS and REACH.

## Features

- High Accuracy of Functioning Temp.
- Non-Resettable
- Organic Thermal Pellet
- Metal Case
- Low Resistance
- RoHS & REACH Compliant

## Applications

- Small Home Appliances
- Comfort Home Appliances
- Personal Care Appliances
- Commercial Appliances
- Automobile Field

## Customization

- Other Temp.
- The Length of Lead Wires
- Taping Packing Available
- Leads Forming Types

## Structure Diagrams

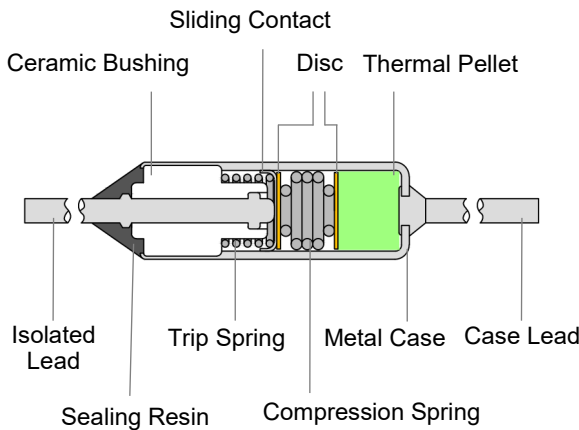

## Marking

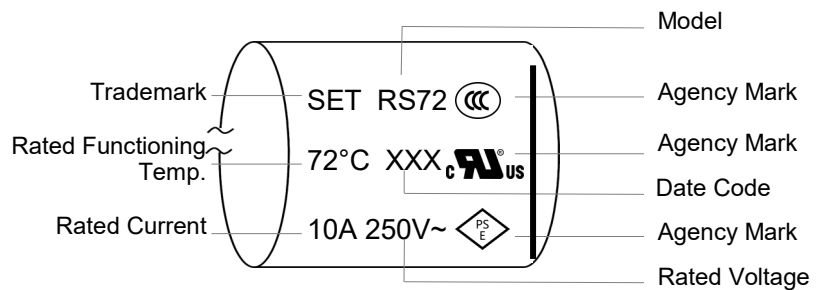

Remark: The Date Code means Year and quarter: A stands for 2000, B stands for 2001 and 01 stands for the first quarter, 02 stands for the second quarter, and so on.

## Dimensions (mm)

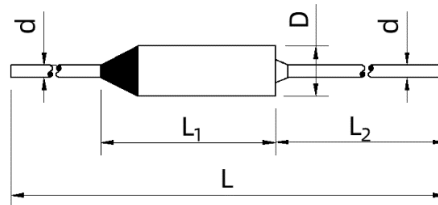

Lead Length	L	L <sub>1</sub>	L <sub>2</sub>	D	d
Standard	65 ± 3	( 14 )	35 ± 2	Φ 4 ± 0.2	Φ 1 ± 0.1
Long	81 ± 3	( 14 )	35 ± 2	Φ 4 ± 0.2	Φ 1 ± 0.1
Option	Customization	( 14 )	Customization	Φ 4 ± 0.2	Φ 1 ± 0.1

Specifications

Rated Functioning Temp. ( $T_f$ ) °C

	Model	Fusing Temp.	$T_h$	$T_h$ (UL/cUL)	$T_m$	$I_r$	$U_r$	$I_n$	$I_{max}$	UL®	cUL®	VDE®	PSE®	KC®	CCC®	RoHS REACH
		(°C)	(°C)	(°C)	(°C)	(A)	(VAC)	(kA)	(kA)	UL	cUL	VDE	PSE	KC	CCC	
263	RS263	261 +2 / -4	N/A	220	480	10	250	1.5	3	●	●	○	○	○	○	RoHS ● REACH *
257	RS257	254 ± 2	200	220	480	10	250	1.5	3	●	●	●	●	●	●	●
240	RS240	238 ± 2	200	205	450	10	250	1.5	3	●	●	●	●	●	●	●
229	RS229	227 ± 2	200	200	450	10	250	1.5	3	●	●	●	●	●	●	●
216	RS216	213 ± 2	186	200	450	10	250	1.5	3	●	●	●	●	●	●	●
205	RS205	203 ± 2	175	190	450	10	250	1.5	3	○	○	○	○	○	○	●
192	RS192	190 ± 2	162	177	300	10	250	1.5	3	●	●	●	●	●	●	●
184	RS184	181 ± 2	154	169	250	10	250	1.5	3	●	●	●	●	●	●	●
172	RS172	170 ± 2	143	157	260	10	250	1.5	3	●	●	●	●	●	●	●
167	RS167	164 ± 2	137	152	220	10	250	1.5	3	●	●	●	●	●	●	●
152	RS152	149 ± 2	122	137	205	10	250	1.5	3	●	●	●	●	●	●	●
144	RS144	141 ± 2	114	129	300	10	250	1.5	3	●	●	●	●	●	●	●
134	RS134	131 ± 2	104	119	250	10	250	1.5	3	●	●	●	●	●	●	●
128	RS128	124 ± 2	98	113	200	10	250	1.5	3	●	●	●	●	●	●	●
121	RS121	118 ± 2	93	106	300	10	250	1.5	3	●	●	●	●	●	●	●
117	RS117	114 ± 2	88	102	200	10	250	1.5	3	●	●	●	●	●	●	●
110	RS110	108 ± 2	82	95	240	10	250	1.5	3	●	●	●	●	●	●	●
104	RS104	102 ± 2	74	89	250	10	250	1.5	3	●	●	●	●	●	●	●
99	RS99	95 ± 2	69	84	200	10	250	1.5	3	●	●	●	●	●	●	●
94	RS94	91 ± 2	64	79	300	10	250	1.5	3	●	●	●	●	●	●	●
84	RS84	82 ± 2	54	69	200	10	250	1.5	3	●	●	●	●	●	●	●
77	RS77	74 ± 2	50	62	300	10	250	1.5	3	●	●	●	●	○	●	●
72	RS72	69 ± 2	42	57	180	10	250	1.5	3	●	●	●	●	○	●	●

Note:

1. "●"Means certificated, "○"Means non-certificated, RoHS & REACH Compliant. "\*" indicates that RS263 complies with REACH Directive 1907/2006/EC, SVHC Candidate List, Batch 29, Item 235 for most of the content (please consult SET for details).
2. For  $T_h$  test, UL / cUL standard recommends the thermocouples to monitor the temp. of OTCO body, while other standards recommend the thermocouples to monitor the environment temp. in the oven.
3. RS series with a  $T_f$  rating 175°C and above comply with UL conductive heat aging (CHAT) requirements.

Temp. Rise (Reference)

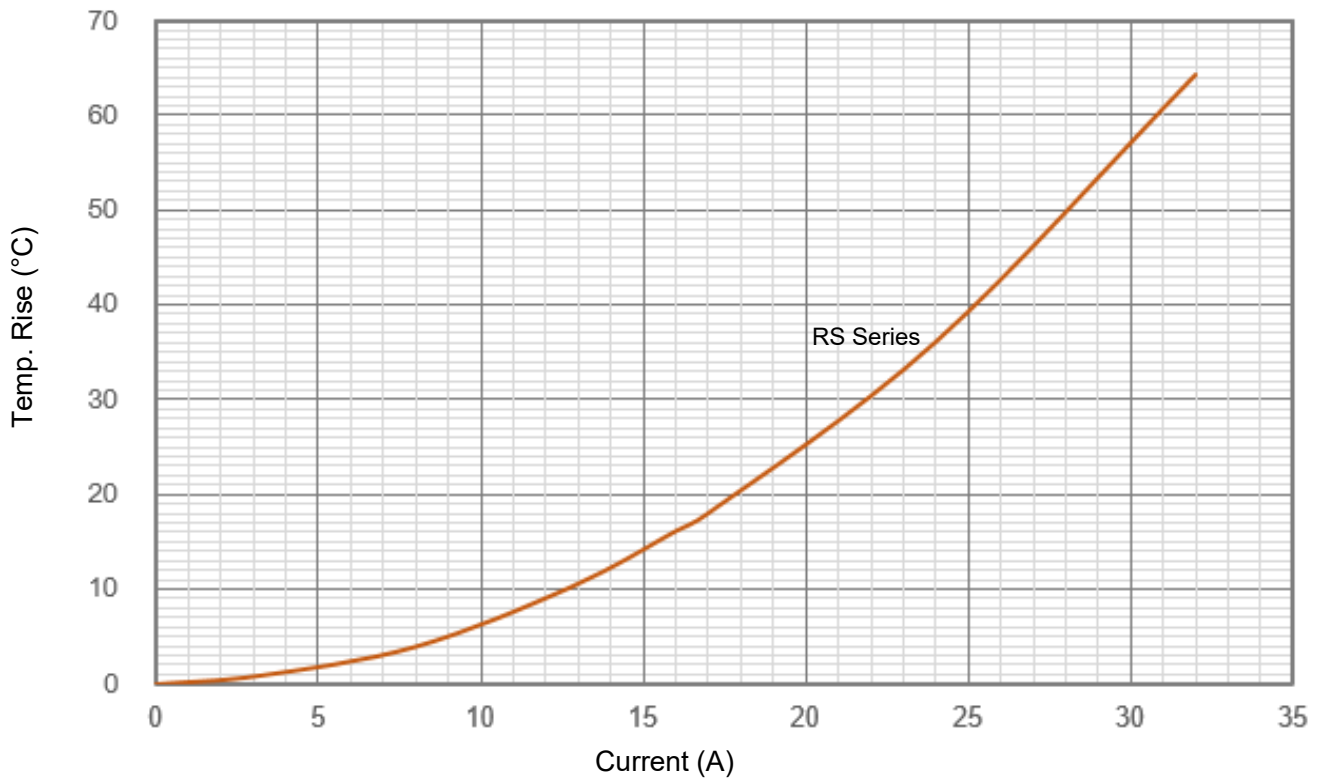

Response Time (Reference)

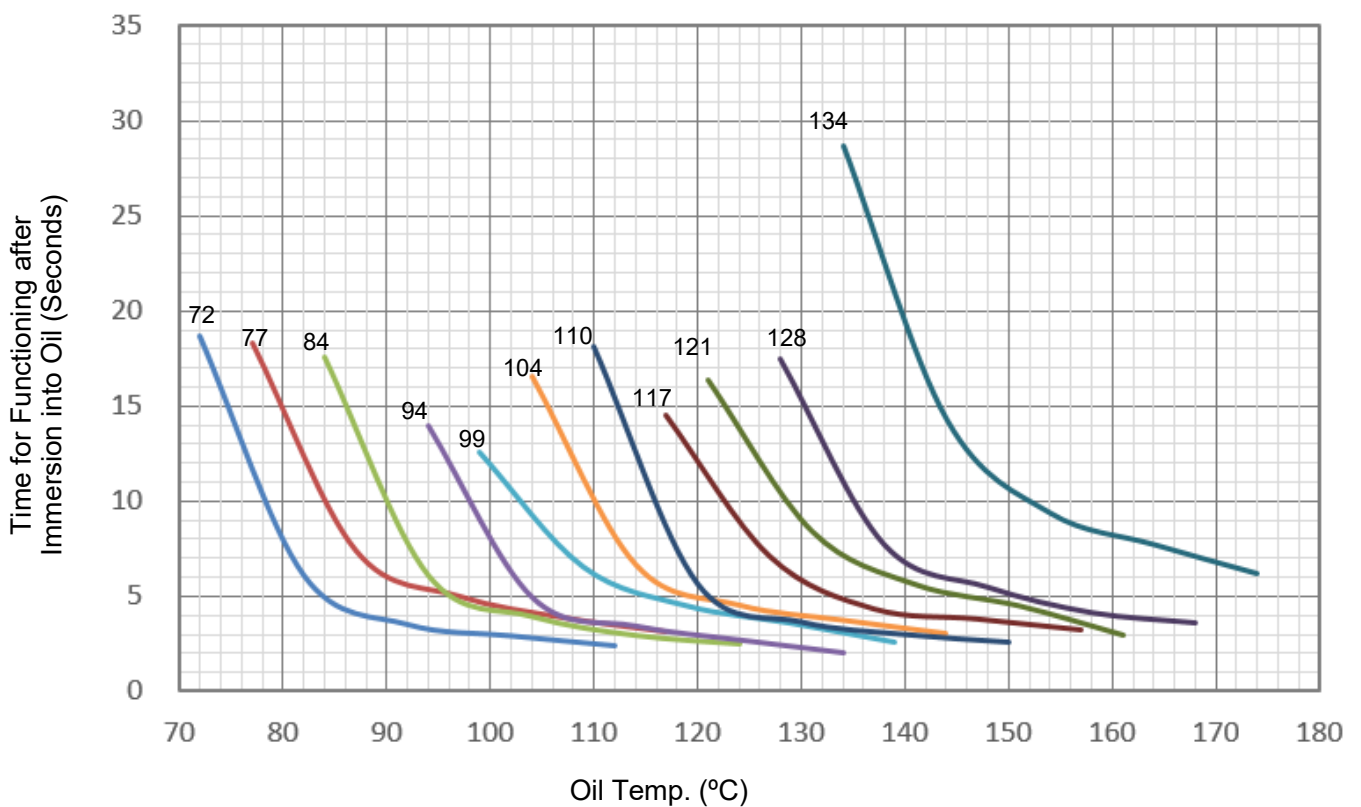





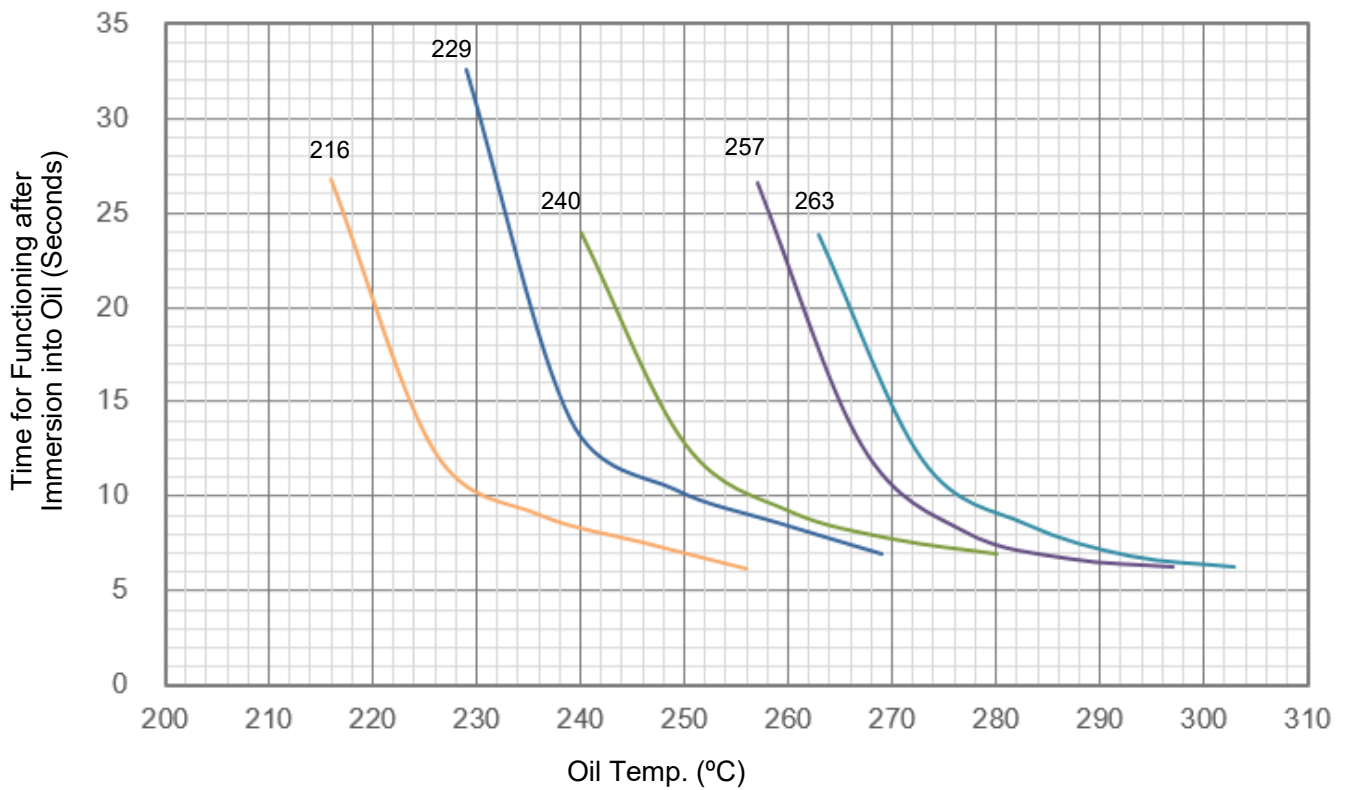
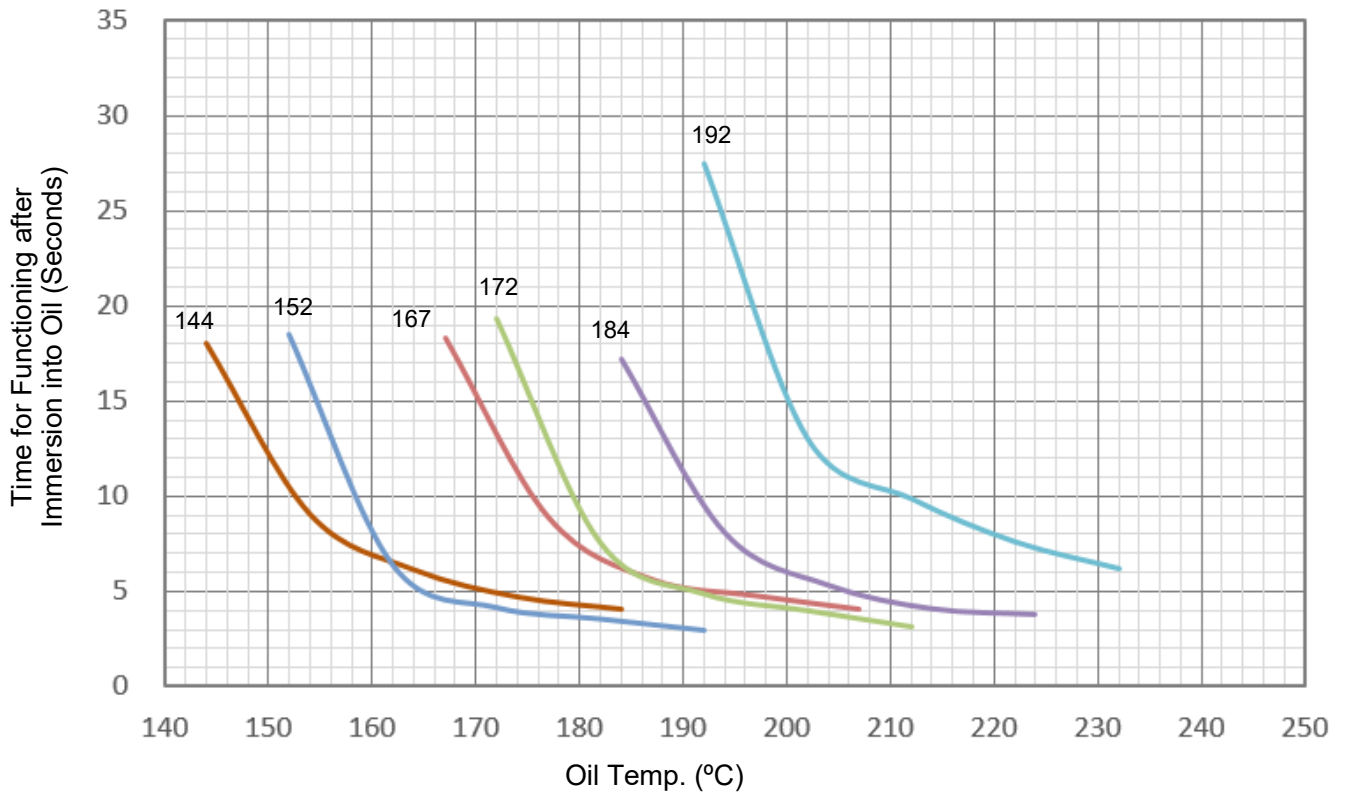

Thermal-Link (OTCO)-Organic Type

RS Series  $I_r$ : 10A



### Agency Information

Agency Symbol	Standards	The File No. and certification No. obtained by SETsafe   SETfuse
	UL60691	E214712
	CAN-CSA-E60691	E214712
	EN60691	40052266
	J60691	JET2121-32001-2001、JET2121-32001-2002 JET2121-32001-2003、JET2121-32001-2004 JET2121-32001-2005、JET2121-32001-2006 JET2121-32001-2007、JET2121-32001-2008 JET2121-32001-2009、JET2121-32001-2010
	KC60691	SU05023-19001A、SU05023-19002A SU05023-19003B、SU05023-19004B SU05023-19005B
	GB 9816.1	2020980205000192

### Packaging Information

#### 1.Bulk

Item	PE Bag	PE Bag	Carton
Dimensions (mm)	135 x 85	220 x 190	346 x 316 x 156
Quantity (PCS)	100	1000	10000
Gross Weight (kg)			11 ± 10%

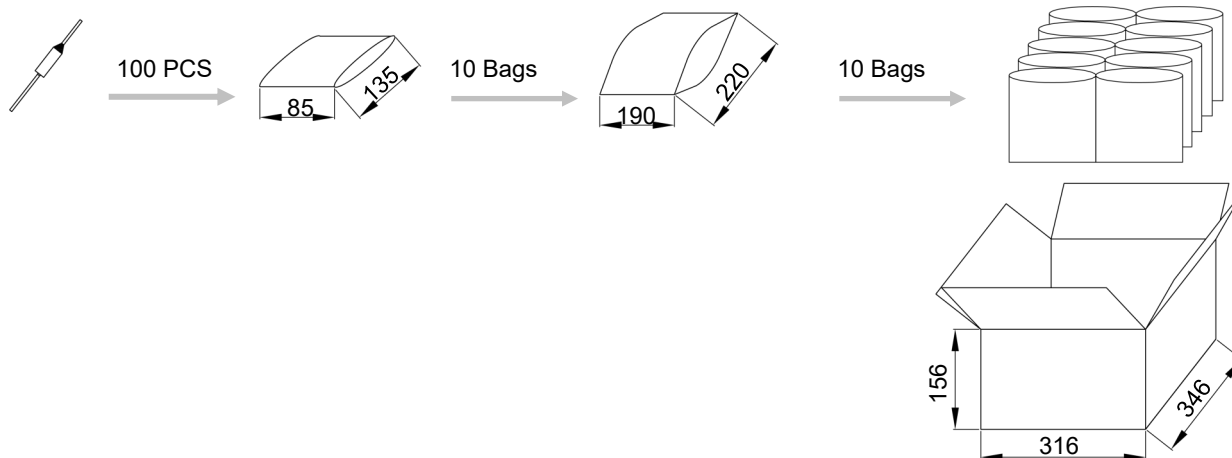

## 2.Taping

Item	Scroll	Box	Carton
Dimensions (mm)	Φ 250 x Φ 85 x 70	258 x 258 x 82	455 x 315 x 285
Quantity (PCS)	2000	2000	10000
Gross Weight (kg)			12.7 ± 10%

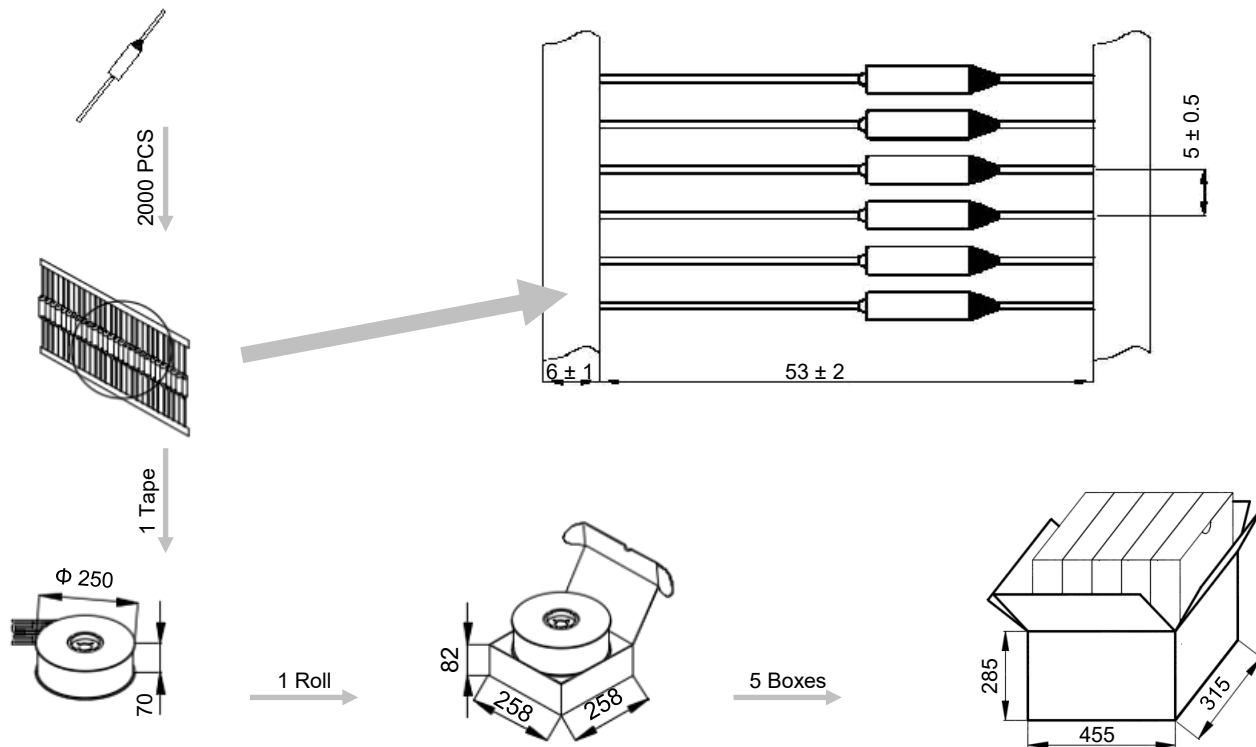

### Part Numbering System

OTCO - RS 72 - L S A B - 001

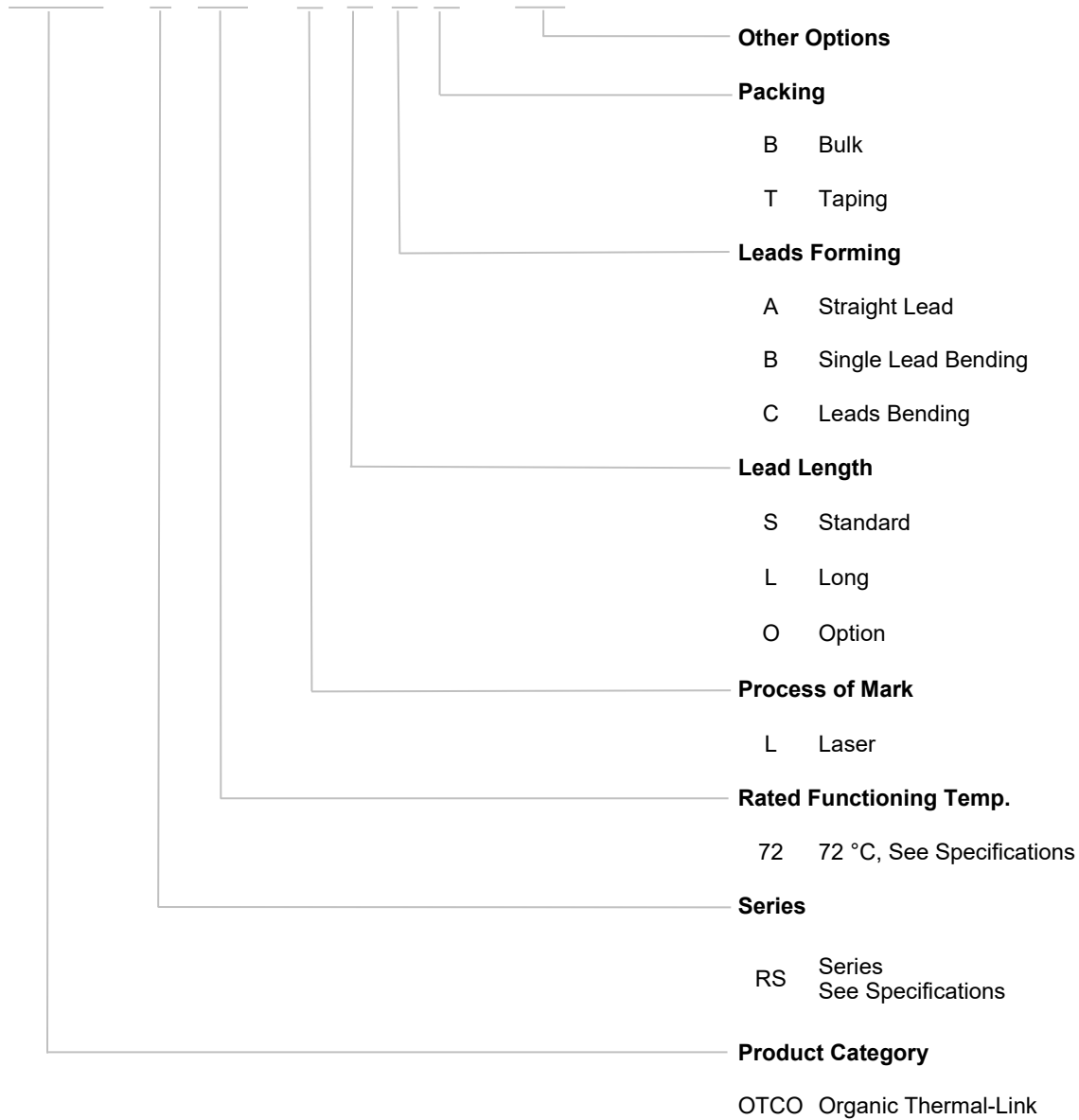

## Glossary

Item	Description
TCO	<p><b>Thermal-Link</b></p> <p>A non-resettable device incorporating a THERMAL ELEMENT which will open a circuit once only when exposed for a sufficient length of time to a temperature in excess of that for which it has been designed.</p> <p style="text-align: right;">— (GB 9816.1)</p>
OTCO	<p><b>Organic Thermal-Link</b></p> <p>Organic type Thermal-Link, organic is the THERMAL ELEMENT.</p>
$T_f$	<p><b>Rated Functioning Temp.</b></p> <p>The temperature of the Alloy Thermal-Link which causes it to change the state of conductivity with a detection current up to 10 mA as the only load.</p> <p style="text-align: right;">— (GB 9816.1)</p> <p>Tolerance: <math>T_f</math> °C (GB 9816.1, EN 60691, K60691). Tolerance: <math>T_f \pm 7</math> °C (J60691).</p>
Fusing Temp.	<p><b>Fusing Temp.</b></p> <p>The temperature of the Alloy Thermal-Link which causes it to change its state of conductivity is measured with silicone oil bath in which the temperature is increased at the rate of 0.5 °C to 1 °C / minute, with a detection current up to 10 mA as the only load.</p> <p style="text-align: right;">— (GB 9816.1)</p>
$T_h$	<p><b>Holding Temp.</b></p> <p>The Maximum temperature at which a Alloy Thermal-Link will not change its state of conductivity when conducting rated current for 168 hours.</p> <p style="text-align: right;">— (GB 9816.1)</p>
$T_m$	<p><b>Maximum Temp. Limit</b></p> <p>The temperature of the Alloy Thermal-Link stated by the manufacturer, up to which the mechanical and electrical properties of the Alloy Thermal-Link having changed its state of conductivity, will not be impaired for a given time.</p> <p style="text-align: right;">— (GB 9816.1)</p>
$I_r$	<p><b>Rated Current</b></p> <p>The current used to classify a Alloy Thermal-Link, which is the Maximum current that Alloy Thermal-Link allows to carry and is able to cut off the circuit safely.</p> <p style="text-align: right;">— (GB 9816.1)</p>
$U_r$	<p><b>Rated Voltage</b></p> <p>The voltage used to classify a Alloy Thermal-Link, which is the Maximum voltage that Alloy Thermal-Link allows to carry and is able to cut off the circuit safely.</p> <p style="text-align: right;">— (GB 9816.1)</p>
$I_n$	<p><b>Nominal Discharge Current</b></p> <p>Being able to withstand 15 peak currents of waveform 8/20 <math>\mu</math>s to test the product's durability of withstanding pulse current.</p> <p style="text-align: right;">— (UL 1449)</p>
$I_{max}$	<p><b>Max. Discharge Current</b></p> <p>Being able to withstand 1 peak current of waveform 8/20 <math>\mu</math>s to test max. pulse current that the product can withstand.</p> <p style="text-align: right;">— (UL 1449)</p>





# ATTENTION

## Usage

1. Please use OTCO without exceeding the rated current and voltage.
2. Do not use the OTCO in environments out of the standard specifications, such as those containing sulfur dioxide gas, nitrogen oxide gas, ammonia gas or formic acid. It is also not suitable for using in high humidity environment or immersed in liquid.

## Replace

OTCO is a non-repairable product. For safety aspect, it shall be replaced by an equivalent OTCO from the same manufacturer, and mounted in the same way.

## Storage

1. OTCO must be kept in a place with no sunshine or corrosive gas, the temperature shall be within 10 °C ~ 30 °C and humidity within 30 % ~ 70 %. The validity storage period of OTCO is 12 months after purchase.
2. The case and isolated lead of OTCO are silver-plated. Therefore, to avoid vulcanization, the OTCO shall not be kept around materials such as cardboard or rubber etc. which generate sulfurous acid gas.

## Lead Process

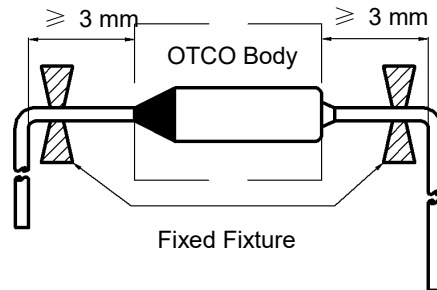

FIGURE 1

1. If lead wires has to be bent, it is important not to apply excessive pressure to the root of the lead wires. The tensile forces applied to the lead wires shall not exceed 15.7 N, and the thrust force applied to the lead wires shall not exceed 3.9 N.
2. The lead wires should be bent at a distance 3 mm or above from the body of OTCO (see Fig.1).
3. To avoid damaging the OTCO, when bending lead wires, please use pincher or similar tools to fix the OTCO.

## Installation

### Selection of Installation Location

1. Do not locate the OTCO in a place where severe vibration always occurs.
2. To reduce the deviations between the temperature design and the actual situation, it is recommended that the OTCO be install ed in close to the thermostat or temperature sensor.

### Make Sure the Temp. of Installation Location

1. The body of OTCO will generate heat as current flows through it, resulting the body temp. higher than ambient temp. The influence of temp. rise shall be considered in the design to determine the appropriate OTCO model.
2. It Considering possible temperature shock situations, it is recommended that the temperature of the body and the ambient temperature of the installation location during the operation of the temperature fuse should not exceed  $(T_h - 10)^\circ\text{C}$ .
3. The end product should be tested to ensure that potential abnormal conditions do not cause ambient temp. to exceed the  $T_m$  of the OTCO.

## Mounting OTCO

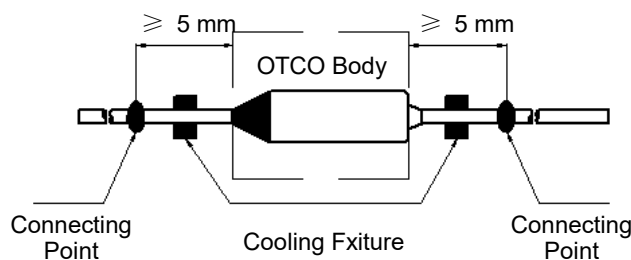

FIGURE 2

1. OTCO can be installed by soldering, welding, riveting or crimping. During and after installation, please do not pull, push or twist OTCO body or lead wires.
2. The connection point of the lead shall be no less than 5 mm away from the OTCO body (see Fig.2).
3. Try to ensure that the body of the OTCO is evenly heated. If the temp. difference is inevitable, make sure that the sealing resin side is connected close to the heat source.

**Soldering**

1. Soldering should be carried out according to below table. If secondary soldering is required, wait until the OTCO cools to room temp.
2. Soldering is not recommended for Thermal-Link with  $T_f \leq 110^\circ\text{C}$ , while non heating processes such as crimping and riveting are recommended.
3. In the process of soldering, cooling fixture should be used between soldering point and OTCO body (see Fig.2).
4. It is recommended to take X-ray after soldering, to confirm that the thermal pellet has no shrinkage after soldering.

**TABLE 1:** Max. Allowable Soldering Time for Different Length of Soldering Point from OTCO Body

Rated Functioning Temp. ( $T_f$ )	Length	Time	Length	Time	Length	Time	Max. Soldering Temp.
( $^\circ\text{C}$ )	(mm)	(s)	(mm)	(s)	(mm)	(s)	( $^\circ\text{C}$ )
$\leq 110$	5	N / A	15	N / A	25	N / A	400
111 ~ 150	5	N / A	15	1	25	2	
151 ~ 190	5	1	15	2	25	3	
$\geq 191$	5	1	15	3	25	5	

**Welding**

1. Avoid welding current flowing into the inside of the OTCO. The welding current will cause the internal parts to be welded together, resulting in the failure function of OTCO.
2. During the welding process, the lead wires of the OTCO must be supported to avoid the damage of the OTCO.
3. In the process of welding, cooling fixture should be used between welding point and OTCO body (See Fig.2).
4. It is recommended to take X-ray after welding, to confirm that the thermal pellet has no shrinkage after welding.

**Riveting or Crimping**

1. Select materials with low resistance (such as copper) for riveting and crimping.
2. Contact resistance shall be as small as possible. Large contact resistance will cause high temp. to make OTCO open in advance.
3. It is better to crimp OTCO leads to stranded lead wires rather than solid wires as the stranded wire may be crimped tighter and maintain better electrical contact during temp. cycling.
4. During the riveting and crimping process, ensure that the lead wires shall not be reversed, sealing resin shall not be destroyed.
5. When the working temp. exceeds  $150^\circ\text{C}$ , soldering reinforcement is recommended after riveting and crimping.

The isolated lead is forbidden to contact OTCO body directly to avoid short circuit (See Fig.3).

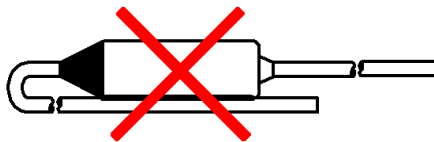

**FIGURE 3**

# Thermal-Link (OTCO)-Organic Type

RS Series  $I_r$ : 10A

## Thermal-Link (OTCO)-Organic Type Features & Model List Overview

